



**INNOVATIVE
INDUSTRIAL
SOLUTION
JEONGSAN.CO.,LTD**



Contents

CEO MESSAGE	02
MANAGEMENT PHILOSOPHY	03
OUR CUSTOMERS	04
COMPANY OVERVIEW	05
MAIN BUSINESS	07
PRODUCTS	09
BRAND	10
HANDLING EQUIPMENT	11
REFERENCE LIST	15
AGENCY	17



Greetings CEO MESSAGE

As an industrial machinery and equipment trading company, Jeongsan Co., Ltd supplies the best products with speed and accuracy in accordance with local and international industry development based on our 40 years experience and techniques .

With a development of lots of products and fluctuation in products price and exchange rate day by day, speedy and accurate information is urgently needed. Jeongsan has made sole agent contracts with about 20 companies in worldwide such as Europe, America, Japan and etc. and all staffs are dedicating themselves to technical support and customer service.

To achieve its goal to lead the market with differentiated products and be a competitive WORLD'S BEST BUSINESS PARTER, Jeongsan is making an effort to create customer value with the best service.

Furthermore, Jeongsan will become a more rapid and active company to contribute to industry development in the country and offer integrated service to the customers with its regional and industrial agencies all over the country under its management policy; All staff's professionalization with a pride of supplying world's best quality products.

In addition, Jeongsan will be a specialized leading supplier of industrial machinery and measuring equipment by meeting the customers' requirements in any conditions with its rational management.

CEO *Seok-Hwan Kim*

Company Motto



Vision

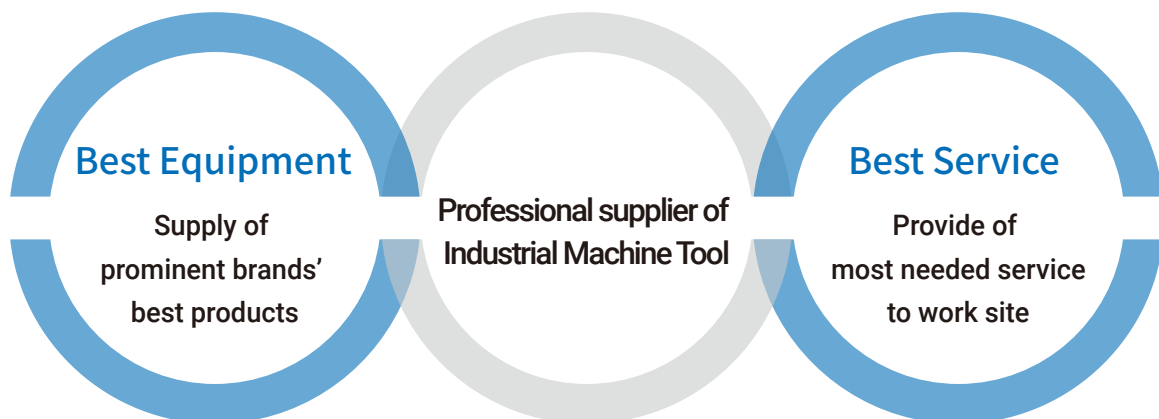

Management Goals



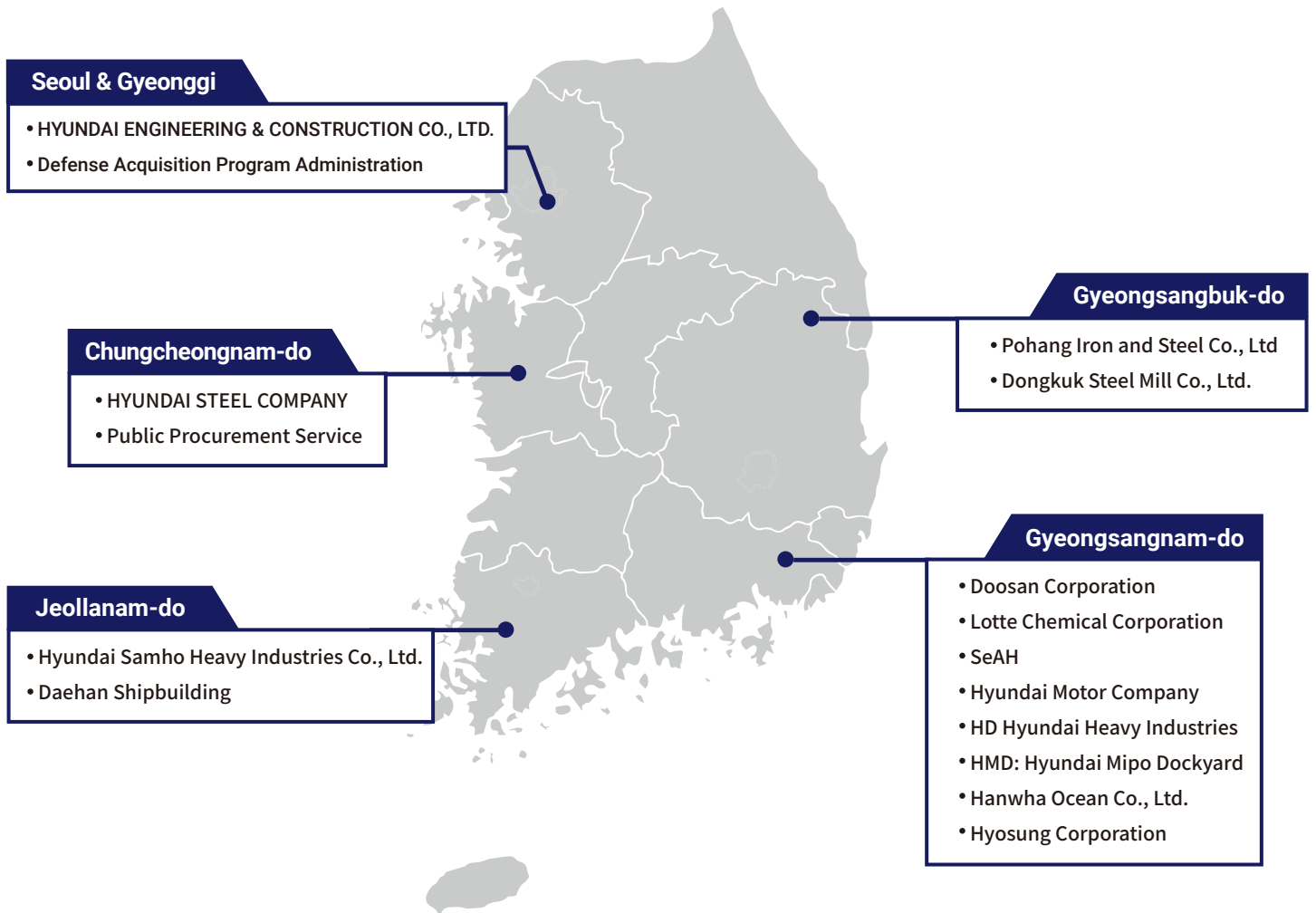

 Daehan Shipbuilding	 Dongkuk Steel	 Doosan	 Lotte Chemical
 DAPA	 SeAH	 PPS	 POSCO
 Hanwha Ocean Co., Ltd.	 Hyundai E&C	 Hyundai Mipo Dockyard	 Hyundai Samho Heavy Industries
 Hyundai Motor Company	 Hyundai Steel	 Hyosung Corporation	 HD Hyundai Heavy Industries

01 COMPANY PROFILE



- Industrial machinery and tools supply for Heavy industry, Shipbuilding Industry
- Maintenance machinery and tools supply for process industry such as Steel, Metal, Chemistry and etc.
- Regional agencies operation and management over the country
- Sole sales agency contracts with world-wide brand companies such as in America, Europe, Japan and etc.
- Sales agency contracts with local high quality makers
- Independent department operation for overseas project on turn-key basis
- **Cost reduction** with improvement of work efficiency, accuracy and production quality
- After-sales service network all around the country
- JIG, TOOLS , PUMP PART manufacturing and assembly capacity

02 FIELD OF BUSINESS

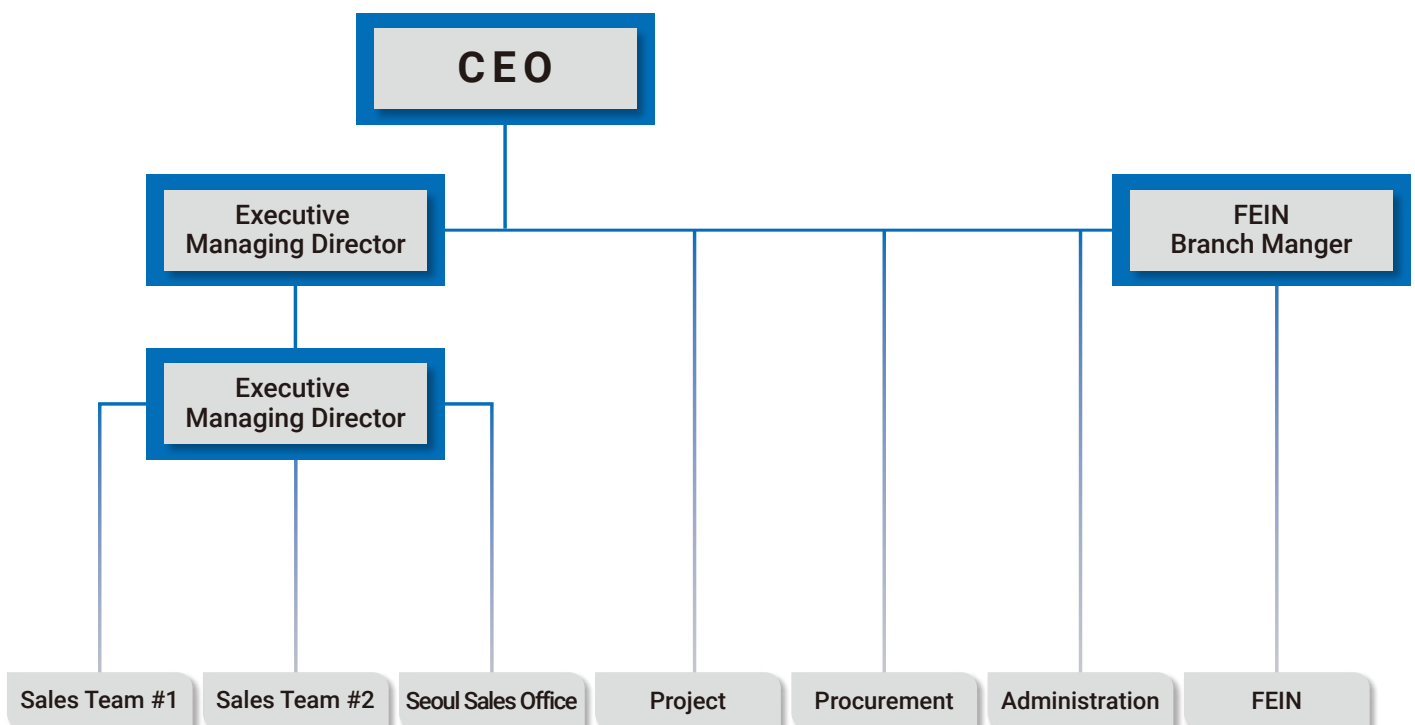

03 COMPANY HISTORY

- 2010~ ● 2017. 01 Registered as a certified partner of Lotte Chemical
- 2016. 12 Registered as a certified partner of Hyundai Steel
- 11 Registered as a certified partner of Poongsan
- 01 Registered as a certified partner of Hyosung
- 2015. 07 Participated in POSCO B2B Auction
- 2014. 04 Registered as a certified partner of Dongkuk steel
- 2013. 05 Acquired ISO-14001
- 03 Registered as a certified partner of the Defense Acquisition Program Administration
- 2011. 04 Registered as a certified partner of Daewoo Shipbuilding & Marine Engineering (DSME)
- 03 Received a citation from the Minister of Knowledge and Economy (Day of Commerce and Industries)
- 2010. 09 Acquired ACHILLES JQS certificate for offshore installatio
- 2009. 07 Established a tool and jig manufacturing plant(462m²)
- 2008. 06 Obtained MAIN BIZ Certificate
- 05 Acquired ISO-9001
- 2007. 07 Contracted a joint investment with FEIN HQ Germany
- 2006. 03 Won a contract of turnkey base workshop equipment of H.H.I. ACPO project and supply
- 2005. 03 Received a citation from the superintendent of Ulsan Tax Office
- 05 Moho Bilondo FPU Start project
- 2004. 05 Moved HQ (to Samsan-dong)
- 2003. 09 Upgraded computing system
- 1990~2000 ● 2000. 04 A.P.Moller Start project
- 1993. 09 Launched nationwide sales and customer service system
- 07 Established Jeongsan Trade Co., Ltd. Exclusive agency contract for the local distributor with FEIN Germany
- 02 Selected as an excellent partner by the CEO of Hyundai Heavy Industries
- 1990. 05 Established computing system
- 02 Licensed as a trading company Moved HQ (to Dal-dong)
- 1980~1989 ● 1989. 03 Awarded a citation form the Chamber of Commerce & Industry, Ulsan HQ
- 1988. 01 Selected as an excellent partner by Hyun
- 1970~1979 ● 1981. 01 dai Mipo Dockyard Moved HQ (Shinjeong-dong)
- 1978. 08 Registered as a certified partner of Hyundai Industries (HHI)
- 1977. 07 Founded (tools wholesale)

04 AUTHENTICATION CERTIFICATE



ISO 9001:2008



ISO 14001:2004



MAIN BIZ CERTIFICATE

01 SALES TEAM

- Offering One-Stop Solution by the person in charge for each contract
- Offering Best Solution by site visiting
- Offering responsible service by the person in charge for each contract

Heavy Industries / Shipbuilding



- Machine, tools, measuring instrument and etc. supply and service
- Special equipment supply for offshore project
- Offering customized solution and equipment supply according to OWNER company's Needs

Steel / Metal / Chemistry



- Participation in bidding and unit price contract through B2B agency
- Maintenance equipment and tools supply for maintaining facilities by visiting the site

Public Procurement Service / Korea On-Lin E-Procurement System /

Defense Acquisition Program Administration



- Order and supply through nation comprehensive electronic procurement

Main handling equipment

- Hydraulic tools: hydraulic cylinder, hydraulic pump, hydraulic torque wrench, hydraulic tensioner
- Measurement: Infrared camera, endoscopic camera, cable tester, insulation tester, multimeter
- Power tools and others: Power tools, electric and pneumatic impact driver, electric and pneumatic grinder, various hand tools

02 PROJECT TEAM Workshop & Laboratory Turnkey Service

- Overseas Onshore & Offshore plant project,
- Workshop and Lab Equipment Turn-Key project execution

Business area (Scope of Work)

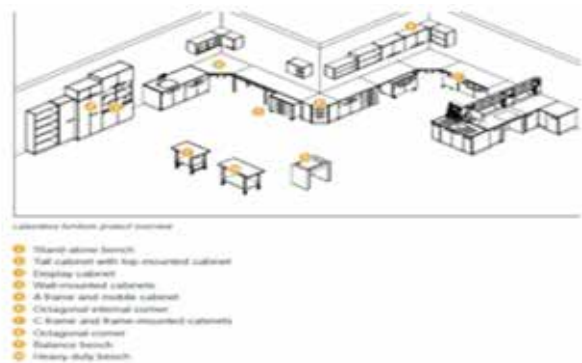

- Total equipment proposal, supply, installation and inspection of laboratories, workshops and maintenance equipment
- Documentation work for overseas construction
- Lab and Workshop Room Lay-Out Design, General Arrangement Drawing.

Major Oil Company project execution

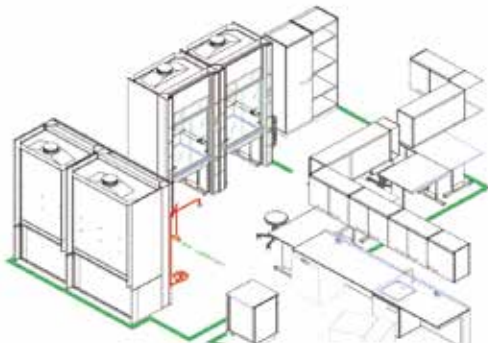

3D Modeling for Laboratory

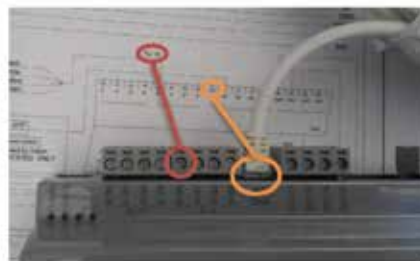

After Sale Service

Installation instruction for Damaged Part



Main handling equipment

Workshop Equipment

Mechanical Workshop
 Electric/Instrument Workshop
 Automobile Workshop
 Welding Workshop

Workshop furniture,
 Storage rack,
 Maintenance tool set

Laboratory Equipment

Laboratory Furniture
 Testing Equipment
 General Equipment
 Glassware

Gymnasium equipmen

Aerobic exercise
 Weighting exercise

PRODUCTS



Hydraulics

Holmatro / Enerpac / Tecpos



Bolting

ENERPAC / SPX / Norbar / Kanon



Power Tools

FEIN / Bosch / Milwaukee / DeWALT



Electrician Tools

Knipex / Lobster / Rennsteig / CATU



Machine

Scantool / Knuth



Hand Tools

Proto / EGA-Master / KS TOOLS
OZAT / TONE / Gom Hammer



Piping

Rothenberg / GBC / REMS



Measuring

Chauvin Arnous / Mitutoyo



Lifting

Thern / JDN / National Clamp

*Jeongsan Co., Ltd. provides excellent products and service in business network
with local and international enterprises and is extending business field with the globalized network.*



WORKSHOP

Mechanical Workshop

Lathe, Milling machine, Drilling Machine, Grinding machine, Hydraulic Press, Surface grinder, Guillotine cutting machine, Sawing machine etc.



Electric / Instrument Workshop

Valve Pressure Testing Equipment, Electric / Pneumatic Test bench, Hydraulic Test equipment, Alignment tool, Oscilloscope, Earth tester Multi meter / Clamp Meter etc.



Automobile Workshop

Vehicle lift, Car ramp, Lubrication equipment, Battery Booster, LED lamp, Cleaning equipment, Hydraulic Jack, Car maintenance tool etc.



Welding Workshop

Welding machine (MMA, Tig), Electrode oven, Fume extractor, Oxyacetylene cutting set, Welding Protection Gear Post Welding Heat Treatment tool (PWHT) etc.



Workshop furniture, Storage rack, Maintenance tool set



LABORATORY

Laboratory Furniture Chemical resistant system furniture

Fume cupboard, Water sink, Working table, Eye washer & shower, Desk, stool, cabinet etc.



Testing Equipment

Water Analysis equipment : Conductivity meter, pH meter, Do Meter, Spectro photometer etc.

Fuel, Oil Analysis equipment : Bomb oxygen calorimeter, Hydrometer, Viscometer, Titrator etc.

Gas Analysis equipment : Gas Chromato graphm, Dew-point Meter etc.



General Equipment & Glassware

Oven, Refrigerator, Balance, Electric Stirrer, Thermometer, Beaker, Bottle, Burette, Tube, Dish, Flask, Pipette, Pinset, Spatula, Clamp, etc



GYMNASIUM

Aerobic exercise

Treadmill, Recumbent bike, Elliptical trainer etc.



Weighting exercise

Weight bench, leg lift, Dumb-bell, Dumb-bel rack, Multi-Gym etc.



ORDER MADE PART

Customized manufacturing and supply for installation according to OWNER's requirement

Laboratory Waste Reservoir

Required a tank to reserve the waste after experiment

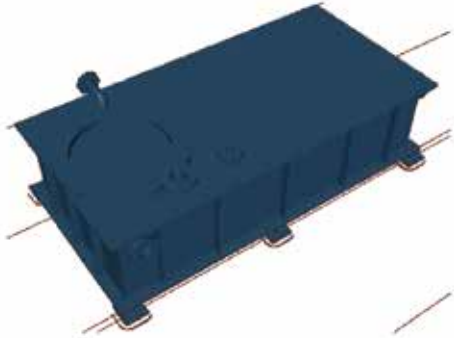
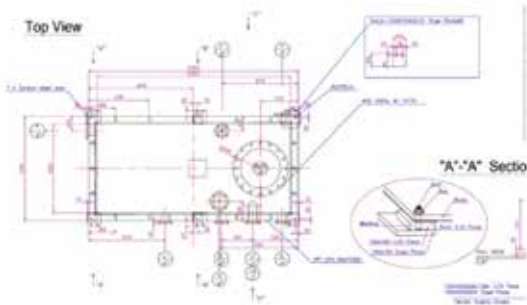

STAINLESS STEEL Gas Rack

Required a SUS316 Gas rack due to sea breeze

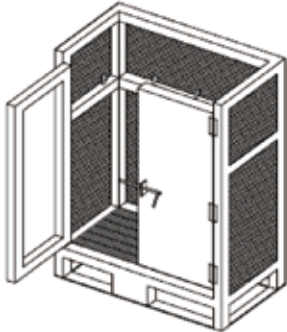
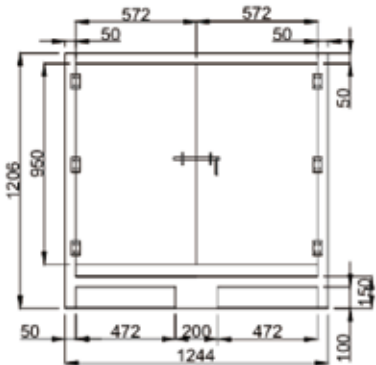

Welding type MACHINE SHEET

Required welding type machine sheet since the machine operates in a vibrating area

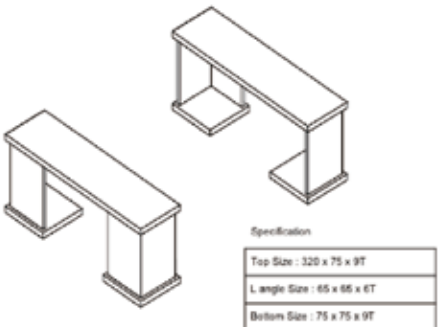
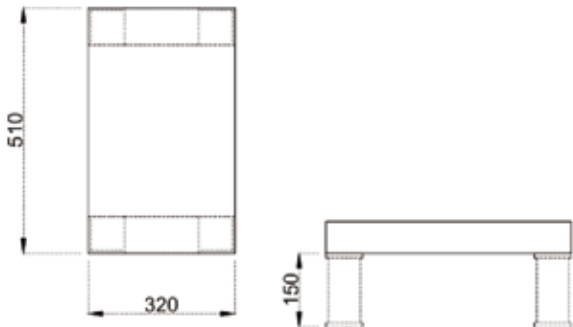

REFERENCE LIST Turn-key basis project list with engineering, equipment selection, supply, commissioning and etc.

Year	Project name	Description	PJT. Owuer
2022 ~2023	P-78 PJT	Workshop Equipment	PETROBRAS
	Shenandoah PJT	Workshop Equipment	BOE
2022	SHWE PHASE 3	Architecture Workshop Equipment	POSCO INTERNATIONAL
2019 ~2020	HMD Ship inventory item	Annual unit price contract for Inventory items	Hyundai Mipo Ship Yerd
2019	ROK military force recovery	Gymnasium Equipments	MND Financial Management Corps Korea
	Military Vehicle Maintenance	Automobile Workshop Equipment	MND Financial Management Corps Korea
2018	Military Vehicle Maintenance	Tire maintenance tools	ROK Army Logistics Command
	ROK Army Maintanace	Torque tools	ROK Army Logistics Command
	ROK Army Maintanace	General tool package	MND Financial Management Corps Korea
	Fishery Patrol Ship Series	Inventory items	Ministry of Maritime Affaires Korea
	ROK Army Maintanace	Armoured Car Maintanace tools	Defense Acquisition Program Admistration Korea (DAPA)
2017	Vehicle gas test equioment	Oil test equipments	MND Financial Management Corps Korea
	Fishery Patrol Ship	Workshop Equipment	Ministry of Maritime Affaires Korea
	Bergarding PJT	Generator Emergenct Gas SKID	PETRONAS
2016	Jangklic PJT	Gymnasium Equipment	ENI MUARA BAKAU B.V
	Baronia PJT	E&I Workshop Equipment	PETRONAS
	Seven Arctic PJT	Welding System	Subseea 7
	Seven Arctic PJT	Maintenance tool package	Subseea 7

REFERENCE LIST

2015	Seven Arctic PJT	Gymnasium Equipment	Subsea 7
	Jangklic PJT	Workshop Equipment	ENI MUARA BAKAU B.V
	Baronia PJT	Workshop Equipment	PETRONAS
2014	Aasta Hansteen PJT	Workshop Equipment	STATOIL
	Moho Nord FPU PJT	Workshop/ Laboratory Equipment	TOTAL
	Seven Arctic PJT	Workshop Equipment	Subsea 7
	AZ Zour North IWPP PJT	Laboratory Equipment	Kuwait Authority for partnership Project (KAPP)
2013	Seven Kestrel PJT	Workshop Equipment	Subsea 7
	BCP PJT	Workshop Equipment	PETRONAS
	Clair Ridge PJT	Workshop Equipment	BP
	Bollsta Dolphin PJT	Welding System	Dolphin Drilling
2012	Quad 204 PJT	Workshop Equipment	BP
	RV Samudra Ratnakar	Laboratory Equipment	Geological Survey of India (GSI)
2011	Goliat PJT	Workshop Equipment	ENI Norgas
2010	SHWE PJT	Workshop/ Laboratory Equipment	Daewoo international
2009	OFON PJT	Workshop/ Laboratory Equipment	TOTAL
2008	BONGKOT PJT	Workshop Equipment	TOTAL
	USAN PJT	Workshop Equipment	TOTAL
2006	AKPO PJT	Workshop Equipment	TOTAL
Before 2006	A.P.Moller / Moho Bilondo FPU		etc.

01 FEIN



2017
현재 그리고 미래에도

FEIN German Power Tool brand for worldwide industrial specialists

“FEIN” Invented the world’s first electric hand drill in Germany and its best performance has been proven by specialists in steel, metal and automotive industries for over 140 years.

Fein has been acknowledged as the leading company in the power tools market

With its techniques and performance based on over 140 years tradition.

02 Holmatro



Holmatro Results-oriented customized high pressure hydraulic solution

“Holmatro” hydraulic equipment and system solutions are predominantly used in rescue, special tactics and industrial applications around the world. These types of applications demand reliable and safe tools under all circumstances. To make sure that users can fulfill their Specialized tasks, we strive to be the best-in-class industry market leader by using game changing technology.

03 Proto



Proto Purchasing “PROTO” is purchasing 110 year-experience

“PROTO” is an American industrial hand tool company which is a division of Stanley Black & Decker.

Contact Proto for world’s widest range of tool and all kinds of tools for working in any fields.

Starter set / Intermediate Set / Modular Set / Advanced Set / Aviation Set / Rail Road Set / HVAC set / Plumbing Set / Contractor’s / Electrician’s Set

04 EGA Master

1000V - VDE 



ANTICHISPA AISLADA 1000V
1000V INSULATED NON-SPARKING
ANTI-DÉFLAGRANT ISOLÉ 1000V



TITANIO AMAGNÈTICA
TITANIUM NON-MAGNETIC
TITANE ANTIMAGNÈTIQUE



USO SUBACUÁTICO
UNDERWATER USE
UTILISATION SUBAQUATIQUE



EGA Master It is a premium industrial machinery and tool manufacturer in Spain.

“EGA master” There are more than 200 international patents used in oil, gas, mining, aerospace, automobiles, and civil engineering (underwater tools).

It supplies a variety of high-risk special tools and equipment, including manual tools, pipe tools, 1000v insulation tools, (non-sparking, non-magnetic tools), underwater tools, and ATEX-certified Intrinsically safe/Explosion-Proof equipment.

05 Proglove



Proglove Wearable devices in line with the 4th industry

“Proglove” is, Proglove's Wearable Scanner combines IT systems with industrial processes to help you evolve into a networked, intelligent production system.

Self Insight systems provide integrated information for logistics movement, work process verification, workstation organization, communication and improvement.

Mobile with Bluetooth, USB, WIFI, and Beck-End Integration with Windows

06 Tellure rota



Tellure rota Design and manufacture wheels and casters for industrial, new and home use since 1953.

“Tellure rota” Work with customers to deliver customized solutions in terms of material, dimensional and structural solutions to meet the needs of the field.

07 Thern-Cranes & Winches



Thern With over 70 years of experience, offer the highest quality lifting, pooling and positioning equipment

“Thern” Designed and modified as needed to deliver superior solutions for all applications and full customer satisfaction with solid guarantees such as strict quality standards and fast delivery.

08 PFERD & FERROBOTICS



Jeong San boasts precise technology and provides a system that produces consistent high quality.

The robots and polishing technology of “PRERD & FERROBBTICS” are highly effective in reducing consumables through precise, consistent technology and better cycle time.

The manual environment, which was directly ground by individuals, had the disadvantage of accompanying risks. However, with the introduction of the robot system, a safe working environment can be provided to workers, and labor costs can be reduced through 24/7 continuous work.

09 KS TOOLS



KSTOOLS Competitive price and quality, Variety of maintenance tools for vehicles

“Kstools” as a modern tool supplier has continuously provided every day's solution and innovative tools for the consistently changing requirements in high-tech daily life for 22years. Many of customers around the world are satisfied with the impressive quality, convenience and competitive price

10 Gom Hammer



무반동 해머의 원리

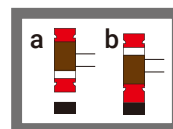

11 ENERPAC



ENERPAC With over 100 years of exceptional technology, it makes field work safer and easier.

“ENERPAC” is the world's leading market leader in products and systems for precision control of high pressure hydraulic tools and high weights.

It produces a wide range of superior products, from low-capacity hydraulic cylinders to computer-controlled lifting and positioning systems. Enerpac designs and manufactures more than 50,000 products in eight manufacturing plants, which are sold worldwide through a network of 1.400 dealerships.

Company JEONGSAN CO.,LTD

Business Industrial Machinery Tools Supply, Trade, Manufacturing
(Laboratory, Machine Equipment, Mechanical, Pneumatic, Electric, Hydraulic, Electrician, Working Tool)

Address Head Office 11 Galbat-ro, Nam-gu, Ulsan, Republic of Korea
Fein branch office 21 Jinjang 17-gil, Buk-gu, Ulsan, Republic of Korea

Founded July 1977

Telephone +82 52 271 7031~7 // +82 52 287 8209

Fax +82 52 271 7050

Website www.jstool.co.kr

E-mail jmt@jstool.co.kr // fein@fein.co.kr

